

Dimension

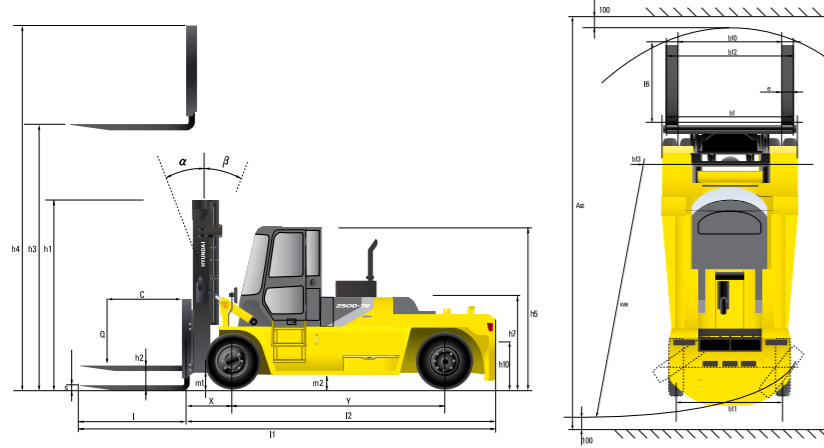

Mast Specification

Mast Type	Maximum Fork Height (mm)	Overall Height Lowered (mm)	Tilt Angle (deg)		Load Capacity (1,200mm LC) (kg)	Truck Weight Unloaded (kg)
			Fwd	Bwd		
V350	3,476	3,600	12	10	25,000	36,633
* V400	4,030	3,877	12	10	25,000	37,021
V450	4,530	4,127	12	10	25,000	37,271
V500	5,030	4,377	12	10	25,000	37,526
V550	5,530	4,627	12	10	24,950	37,788
V600	6,030	4,877	12	10	24,950	38,379
V650	6,530	5,127	12	10	24,450	38,686
V700	7,030	5,377	12	10	23,550	38,968

* STANDARD

Load Capacity

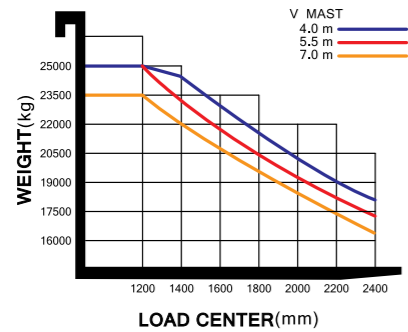

Optional Items

- **FORK (L x W x T)(mm)**
2,450 x 250 x 110(STD) / 2,700 x 250 x 110 / 3,150 x 250 x 110 / 3,650 x 250 x 110 / 3,700 x 250 x 110
- **MCV: 6 - SPOOL**
- **INTEGRATED FORK POSITIONER(INDEPENDENT) + SIDE SHIFT(STD)**
- **AIR COMPRESSOR**
- **TERMINAL WEST FORK CARRIAGE**
- **HANDS FREE**
- **BEACON LAMP**

Specification

Identification		
1.1	Manufacturer	Hyundai
1.2	Manufacturer's type designation	250D-7E
1.3	Drive: electric (battery or mains),diesel,petrol,fuel gas,manual	DIESEL
1.4	Type of operation:hand,pedestrian,standing,seated,order-picker	seated
1.5	Load capacity / rated load	Q (t) 25.0
1.6	Load center distance	c (mm) 1,200
1.8	Load distance, center of drive axle to fork	x(mm) 1,112
1.9	Wheelbase	y(mm) 4,300
Weights		
2.1	Service weight	kg 37,021
2.2	Axle loading, loaded front/rear	kg 57,277 / 4,744
2.3	Axle loading, unloaded front/rear	kg 18,647 / 18,374
Wheels, Chassis		
3.1	Tires:solid rubber, superplastic, pneumatic, polyurethane	Pneumatic
3.2	Tires size, front(width x Φ)	14.00 - 24 - 28PR
3.3	Tires size, rear(width x Φ)	14.00 - 24 - 28PR
3.5	Wheels, number front x rear (x=driven wheels)	4 x 2
3.6	Track width, front	b10 (mm) 2,212
3.7	Track width, rear	b11 (mm) 2,140
Basic Dimensions		
4.1	Mast / fork carriage tilt forward / backward(α / β)	degrees 12 / 10
4.2	Lowered mast height	h1 (mm) 3,877
4.3	Free lift	h2 (mm) 0
4.4	Lift height	h3 (mm) 4,030
4.5	Extended mast height	h4 (mm) 5,837
4.7	Overhead load guard (cab) height	h5 (mm) 3,223
4.8	Seat height / standing height	h7 (mm) 2,150
4.12	Coupling height	h10 (mm) 528
4.19	Overall length	l1 (mm) 8,812
4.20	Length to face of forks	l2 (mm) 6,362
4.21	Overall width	b1 (mm) 3,050
4.22	Fork dimensions	l / e / s (mm) 2,450 x 250 x 110
4.24	Fork-carriage width	b12 (mm) 2,600
4.31	Ground clearance, loaded, under mast	m1 (mm) 300
4.32	Ground clearance, centre of wheelbase	m2 (mm) 250
4.33	Aisle width for pallets 1000x1200 crossways	Ast (mm) 9,569
4.34	Aisle width for pallets 800x1200 lengthways	Ast (mm) 9,569
4.35	Turning radius	Wa (mm) 5,807
4.36	Smallest pivot point distance	b13 (mm) 1,981
Performance Data		
5.1	Travel speed, Unloaded	km/h 31.7
5.2	Lift speed, Loaded/Unloaded	mm/s 250 / 280
5.3	Lowering speed, Loaded/Unloaded	mm/s 400 / 300
5.5	Drawbar pull, Loaded	KN 21.5
5.7	Gradient performance, Loaded	% 33.8
5.10	Service brake	Wet, Hydraulic
Engine		
6.1	Engine manufacturer / type	Cummins QSC
6.2	Engine power acc. to ISO 1585	kW 194
6.3	Rated speed	1/min 2,200
6.4	No. of cylinder / cubic capacity	/cm ³ 8,300
6.5	Fuel consumption acc. To VDI cycle	l / h 25
Other Details		
8.1	Type of drive control	Power Shift
8.2	Operating pressure for attachments(system/attach)	bar 240 / 160
8.3	Oil volume for attachments	Litter 270
8.4	Sound level at driver's ear according to DIN 12 053	db(A) 77



Some of the photos may include optional equipment.

HYUNDAI MATERIAL HANDLING Applied Tier 3 Engine

250D-7E



Head Office (Sales office)

First tower, 55, Bundang-ro, Bundang-gu, Seongnam-si, Gyeonggi-do, Korea

PLEASE CONTACT

www.hyundai-ce.com

2019. 03. Rev.8



MOVING YOU FURTHER

NEW criterion of Big Forklift Truck

Hyundai introduces a new line of 7E-series diesel forklift trucks. Excellent power and performance makes your business more profitable.



Excellent



Cruise Control



Instrument Switch Panel



Air Conditioner & Heater



Rear View Camera



Load Indicator



ESL(Engine Start Limit)

Some of the photos may include optional equipment.

Ability of best, the new master on the job-site!

Smooth running, efficiently and ergonomically designed, 250D-7E series are made to meet your needs.



Powerful Engine

Cummins QSC Engine

The six cylinders turbo-charged engine is built for power, reliability and economy. This engine meets EPA Tier 3 and EU stage IIIA emission regulation.



Engine Control Mode

According to operating load, the operator can select engine mode by changing side panel switch.

STD Mode : Fuel reduction mode for light-duty operating load

POWER Mode : Heavy-duty or operating at slope



Adjustable Engine Low Idle RPM

While engine runs, low idle rpm can be increased by unit of 25rpm and it keeps previously set rpm when engine restarts.

194kW/2,200rpm

120.4kgf-m/1,400rpm

Full-automatic Transmission

Full-automatic transmission gives easy, convenient handling and soft, smooth shifting. The operator can select two kinds of automatic modes. (1st ↔ 3rd, 2nd ↔ 3rd)



Some of the photos may include optional equipment.



Cruise Control

It offers the ability to automatically maintain a desired engine speed with no accelerator pedal input and reduce fuel consumption.



Transmission Control Switch



Excellent Night Work

- Various position of work lamp provides the operator more comfortable and safe operating environments.
- Front : fender(2), mast(2) - Rear : cab(2)

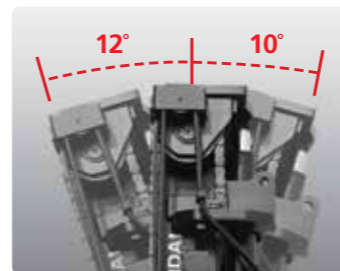

Increased Mast Tilting Angle

Utilizing the mast tilting angle of 12 degrees forward and 10 degrees backward, the operator can perform loading and unloading jobs safely and rapidly.

Faster Travel Speed & Better Gradability

The powerful engine provides greater acceleration, better gradability and faster travel speed on any tough terrains or slopes.



Gradability (Loaded)
250D-7E : 33.8%

Travel Speed (Unloaded)
250D-7E : 31.7 km/h

Ergonomic driving space design!

A design based on human engineering relieves fatigue and increases operator's efficiency.

Operator Friendly Gauges and Water-resistant Monitor Panel



Easily Adjustable Suspension Seat
An attractive and adjustable seat, based on a human engineering design, provides great comfort, safety and durability. (Head Rest - option)



High-output Air Conditioner & Heater (Option)

An air conditioner with integrated the condenser is mounted on upper side of the cabin to make a wide room in the cabin. And an air conditioner with high-output and heater always provide you with comfortable environment when you work.



Some of the photos may include optional equipment.



Rear View Camera
The rear view camera makes the operation more easy and convenient. And it supports 4 camera channels.



Load Indicator
A load can be placed on the fork and can be accurately weighed by measuring the hydraulic pressure.



Centralized Instrument switch Panel



MP3 CD Player & Remote Control



Hands Free Socket (Option)



Quick Response of Operating Control Levers
Only minimal operator's effort is required for precise, safe and productive control. (5-Lever, 6-Function : Standard) (5-Lever, 7-Function : Option)



Ergonomically Positioned Pedals
Based on human engineering the accelerator, brake and inching pedals are optimally positioned for the operator's convenience.



Adjustable Steering Column
Steering handle is adjustable depending on the operator's body shape. Adjustability of steering column makes you more comfortable.



Danger-free through high durability!

Safety and durability are priorities in design of the equipment.



Up-to-date Cooling System

The minimum fuel consumption and low noise are available by applying hydraulic cooling fan sensing intake air temperature, transmission oil temperature, coolant temperature and hydraulic temperature.



OPSS(Operator Presence Sensing System)

Control of mast tilting, lifting and lowering is not possible through operation of the appropriate control when the operators is not in the normal position.



Durable Drive Axle

The planetary reduction drive axle smoothly delivers desired torque to the drive wheels.



Auto Parking

The parking brake is engaged automatically when the transmission is neutral and the operator leaves the seat.



Some of the photos may include optional equipment.



Wet Disc Brake System

The wet disc brake system is virtually maintenance free and is enclosed to protect from dust and water.



Fitted Protector for Hub Bolts

Durability has improved by applying protector for preventing bolts breakage. (Easy parts supply due to the wheel in common with front wheel)



Cabin Tilting Automatic System

Cabin tilting automatic system makes servicing of all power train components quick and easy. An electrically assisted hydraulic actuated cylinder tilts operator cabin to left side about 65 degrees for easy access to inside of truck components.



Grease Fittings

Grease fittings are installed for fast access to steering axle center pin when doing your service checks.



Highly Durable Mast & Carriage Side Roller

Side roller with great durability for mast and carriage is included.



Highly Durable Carriage

The carriage is very strong cause of applying the high tensile structural steel which has a excellent durability.

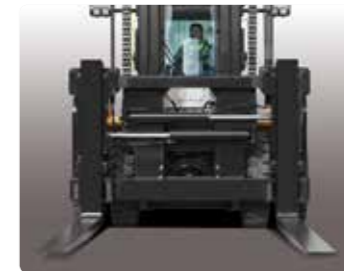

Large Footboard & Handle

Wide "open" step offers convenience and safety when entering and exiting the truck.

Centralized design for easy service!

An ideal arrangement of component parts ensures easy access and convenience for maintenance.



Large Engine Hood

Highly accessible engine compartment assures fast and efficient maintenance.



Easy Change Air Cleaner

This air filter is readily accessible for cleaning or replacement.



Cabin Air Fresh Filter

The internal pressure is maintained to be slightly higher than that of outside to exclude dust and to reduce noise levels.



■ Some of the photos may include optional equipment.



Compact fuse Box for Easy Inspection



Mechanic Friendly Fuel Filter Replacement

Highly accessible engine compartment allows for quick replacement of filters.



Electrically Monitored Air Filter

Air cleaner sensor alerts the operator of a clogged air filter and allows replacement before damage.



Automatic Self Locking Gas Spring

Engine compartment hood is safely opened by a self locking gas spring.



Master Switch

A master switch disconnects the battery power to protect the electrical system from excess electrical drainage.



Large Tool Box



Pressure Gauge Port



Easy Maintenance Oil Check